

User Guide



eassee

Download your language

In order to avoid unnecessary waste of resources by printing the User Guide in different languages, we have chosen to include only English and make other languages available on our website.

You can download this User Guide in other languages here¹

→ www.easee.no/manuals



→ **Join Easee Owners Club** on facebook, and get valuable product insight first!

→ **Follow us** on facebook and Instagram.

¹ We cannot guarantee that all languages are available at this time.

5
7
8
10
12
14
15
16
19
20
24
26
28
29
30

Safety Instructions

Product overview

A smart energy valve

Planning the installation

Your house, power grid and EV

How do I charge?

Smart charging

Charging robot features

Charging robot interface

Wifi interface

Technical specification

Load balancing

Residual current device

Practical details

Light strip error messages

THIS DOCUMENT CONTAINS INFORMATION THAT IS SUBJECT TO CHANGE WITHOUT NOTICE.

The latest version of this publication can be downloaded at easee.no

No part of this publication may be reproduced or transmitted in any form or by any means, electronic or mechanical, including, but not limited to, copying, recording, retrieving data, or computer networks without the written permission of Easee AS.

Easee and all other Easee product names and slogans are trademarks or registered trademarks of Easee AS. Easee products can be protected by one or more patents.

All other products and services mentioned may be trademarks or service marks of their respective owners.

February 2020 - Version 2.11

© 2018 by Easee AS. All rights reserved.

Safety Instructions

Read these instructions thoroughly and get to know the product before installing it.

- The PIN-code is located on the front of the chargeberry and must be used during installation. It is recommended that it be glued to the back of this manual or stored in a safe place
- The product should only be installed, repaired or maintained by authorized electricians and in accordance with national guidelines for electrical installations.
- All applicable local, regional and national regulations must be respected when you install, repair or maintain this device.
- Do not use a damaged product.
- Do not use an extension cord with the charging robot.
- Do not touch the Type 2 connectors or put foreign bodies into them.
- If the charging robot lights up red an error has occurred - read more under troubleshooting.
- The charging robot must be installed on a permanent location. The terminals on the Chargeberry and Backplate are designed for a limited number of plugging cycles.



Product overview

Front cover

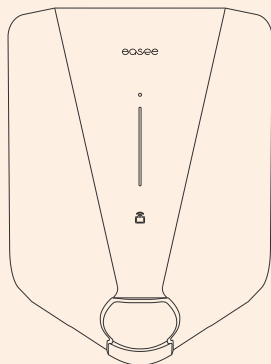

Chargeberry
(Electronics)

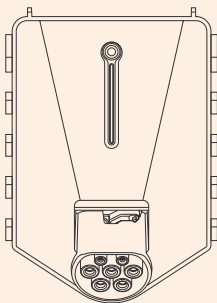

Backplate

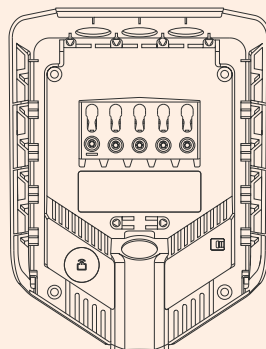

Installation kit



x2



x3



x2



x5



x4



x1

Tool



x1

A smart energy valve for your house and the power grid

We decided to develop a charger that could also be a smart energy device for the home.

Therefore we chose to build the product from scratch and put together technology in a new and revolutionary way. We did this to give you a super-smart charger, but also to save space, costs - and last but not least the environment.

The result was a charger that not only replaces the outlet, but also gives you more power, smarter control and a higher level of security.

All chargers have integrated eSIM and are automatically connected to the mobile network if coverage is sufficient. You can have several chargers per circuit¹ - yet it's super simple for the electrician to install.

The products are also designed to be the DNA of the future electrical grid where they can fully autonomously distribute the energy available at any given time in the network.

It is 70% smaller and lighter than similar solutions, it weighs only 1.5kg and thus saves the environment at least 4kg of copper and plastic per manufactured charger.

Our products are developed and manufactured in Norway.

¹ The Easee Home edition can have up to 3 chargers per circuit, while Easee Charge is fully scalable.

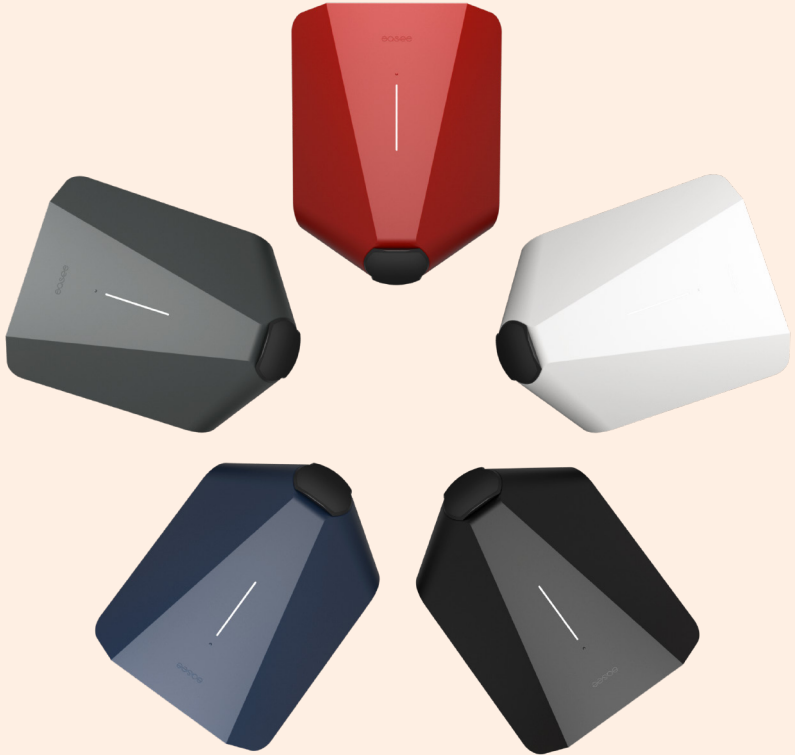

Planning the installation

In advance of starting the installation, it is important that you consider the present and future charging needs. First and foremost, the Easee Charging Robot is a product to be installed by an authorized electrician, and a declaration of conformity must always be provided upon completion by your installer.

NB! For installation of facilities with more than 3 chargers (*Easee Charge*), see separate advice and guidelines at - www.easee.no

Things you should know before you begin the installation

- What is the power rating of the main protective device or fuse.
- How much power can be set aside for charging electric car.
- Which type of electric connection supplies the house.
- Can you use existing infrastructure or you need to add new cable.
- Calculate the cable length from the fuse box to the charger robot.
- Assess the need for the number of charging points now and in the future.

Select protection device and cable type

It is recommended that an external ground fault protection device is installed in accordance with local wiring regulations to protect the supply cable.

See examples of cable types in the table on page 13.

IMPORTANT!

Protection device and cable selection must be recommended and approved by an authorized electrician in accordance with local wiring regulations.

Our recommendations

- Select a 3-phase cable in situations where it is possible.
- Consider the need for additional backplate(s) if the customer plans to acquire more electric vehicles in the future.
- Consider the need for dynamic load balancing with the house/building.
- Always plan for maximum capacity to the charging system.

If these points are followed, this will give the customer a more future proof solution with great flexibility and freedom.

Site Key *(Easee Charge only)*

A Site Key must be used during installation for the system to work properly. To get a valid Site Key the new charging site must be created in the Easee Cloud.

Create an account at <http://easee.cloud> and create the new charging site in advance of installations.

Parallel connection

For installation of several charging robots, we recommend having the cable entry as shown in the figure below. For only one charging robot, use the center hole in the top for a symmetrical and neat installation. It is also possible to have cable entry from the back so that the cable is completely hidden.

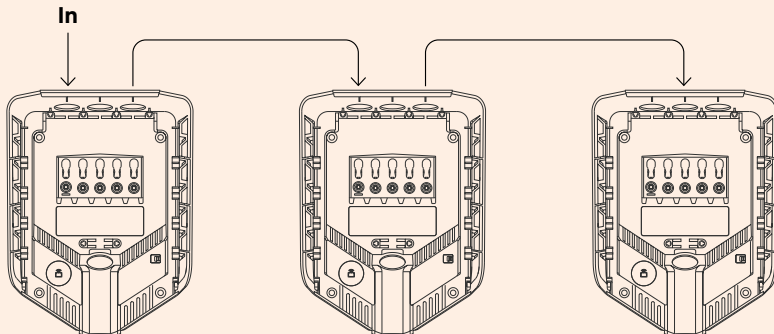

Your house, power grid and electric vehicle

The charging robot will never be the bottleneck. It automatically adapts to the power grid, the electric car and the capacity of your house. In the diagrams below you can see what charging effect you can achieve in your installation and situation.

Circuit fuse²	Charger fuse setting	400V TN	
Ampere (A)	Ampere (A)	1-phase (kW)	3-phase (kW)
10	6	1.4	4.2
16	13	3.0	8.9
20	16	3.7	11
25	20	4.6	13.8
32	24	5.8	17.3
40	32	7.4	22

² Based on max 80% load of the fuse.

Examples of cable types

Cabel	Thickness	Amperage
Description	Number of phases and conductors	Used normally up to
PFXP 3G1.5	1-phase, (2+PE), 1.5mm ²	10A
PFXP 3G2.5	1-phase, (2+PE), 2.5mm ²	16A
PFXP 3G4	1-phase, (2+PE), 4mm ²	25A
PFXP 3G6	1-phase, (2+PE), 6mm ²	32A
PFXP 4G6	3-phase, (3+PE), 6mm ²	32A
PFXP 5G6	3-phase, (4+PE), 6mm ²	32A
PFXP 3G10	1-phase, (2+PE), 10mm ²	50A

How do I charge?

1. Connect the charging cable to the charging robot and your electric car. Charging will start automatically.

If the car does not start charging, check that charging is activated in your car and that the connectors are properly plugged in. If charging still does not start, check what it might be under troubleshooting on page 30.

2. The charger will automatically adapt to the electric car, the power grid and your fuse rating.

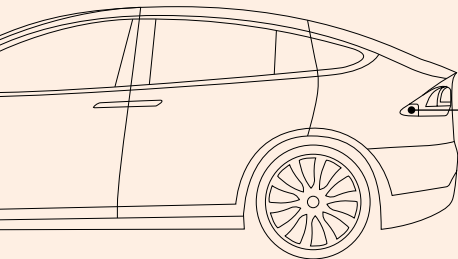

Smart charging

Through your new charging robot it is possible to postpone the charging of the electric car to times of the day, where it will be cheaper to charge.

Smart charging will also help to release electrical capacity in the house at times when power is often needed for things other than charging, such as cooking and water heating.

This is how it works

Electricity prices vary 24 hours a day, and sometimes there is a loss of electricity in the market or an overload of the electricity grid.

By planning and steering when your electric car is being charged, your electricity supplier can trade your electricity in a smarter way. This gives you the opportunity of lower priced electricity when smart charging, depending on which deal you have with your power supplier.

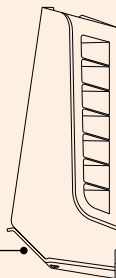

Charging robot features

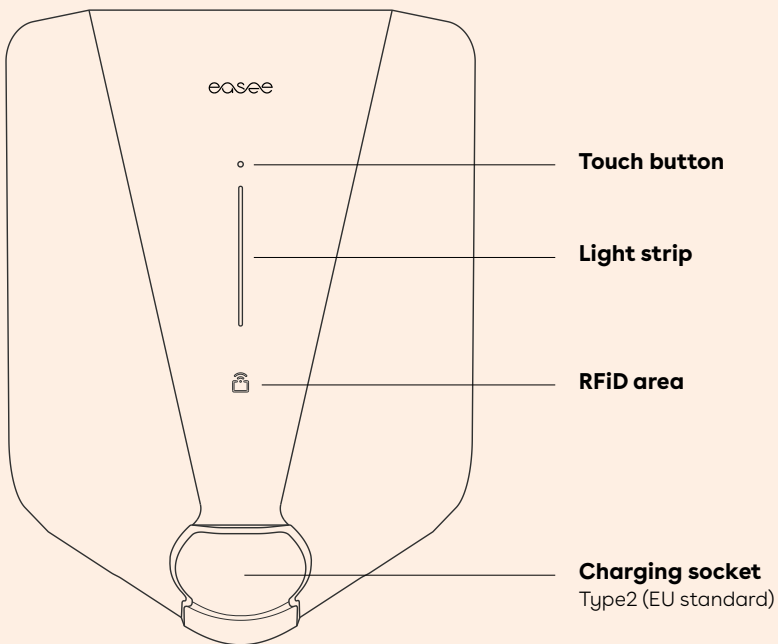

Touch button

With the touch button it's possible to override smart charging in those situations where you need fast charging immediately, if you have smart charging enabled.

Hold your finger on the indicator ball on the front cover for 2 seconds. The charging robot will then cancel the smart charging mode and start charging - the light will then go from blue to white. To reactivate smart charging, hold the touch button for 2 seconds again.

Light strip

The LED strip communicates the status of the charger at all times. Read more about this on page 19 - Charging robot interface.

RFID area

The integrated RFID reader enables access control of the charger and identification of different users. You can use this to lock and unlock the charger using RFID tags you have added.

Charging socket





The Type2 charging socket is completely universal and allows you to charge any type of electric vehicle using the appropriate charging cable (Type 1 or Type 2). This makes it possible to change cars without having to redo the installation and your charger.

Furthermore, it is possible to permanently lock the cable, so you don't have to worry about it being stolen.

NB! The permanent locking of the cable can only be activated when the car is connected.



Charging robot interface

	Status	Light description
	Standby	Light in the bottom of the light strip <i>(A main unit has two diodes lit)</i>
	Car connected	White - constant light
	Charging in progress	White - pulsating light
	Smart charging enabled <i>(Car connected)</i>	Blue - constant light
	Smart charging in progress	Blue - pulsating light
	Updating software <i>(Updating can take up to 30 minutes)</i>	At startup, the LEDs turn on one by one. If there is a software update, one or more LEDs will flash green while this is in progress. NB! <i>The car must be disconnected before a software update can be completed.</i>
	Waiting for authentication	White - flashing light
	RFID-tag received <i>(Awaiting key verification)</i>	White - fast flashing light

Wifi interface

To be able to control your charging robot, you must use a smartphone and connect it to the charger's Wi-Fi network. The name of the Wi-Fi network begins with "Easee ..." and is activated by holding the touch button until the light strip turns green and you hear a confirmation tone.

After connecting, open the browser and type "**192.168.4.1**" into the address field. Then your 4-digit PIN-code must be entered.

You can find the PIN-code on the front of the chargeberry or on the back of this booklet - if the electrician has attached it.

1

Connect to the charging's WiFi network.

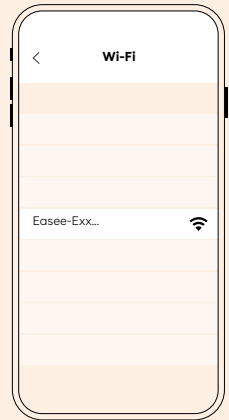
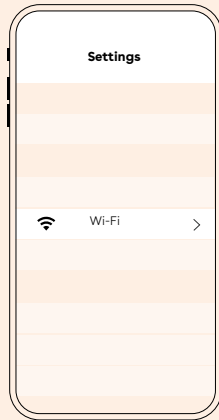

2

Use your browser to log in.

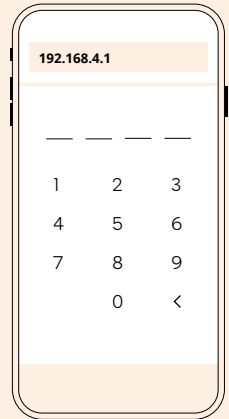
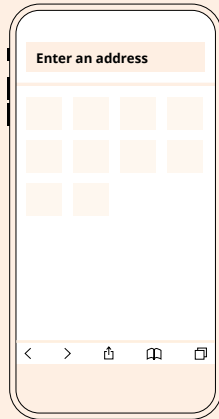

In the status bar the current firmware release is shown together with the signal strength.

Contact information for the owner. This is used if you forget the PIN-code, and will lead to faster and more efficient support, if filled in.

Here you can see and regulate the total current draw for the charging robots that shares the same circuit.

The power output status of the current charging session is shown here.

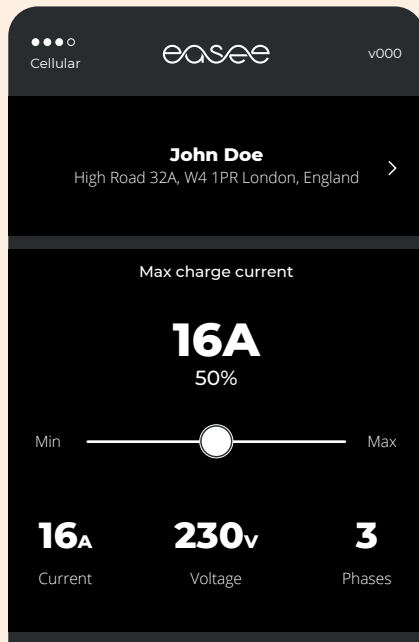

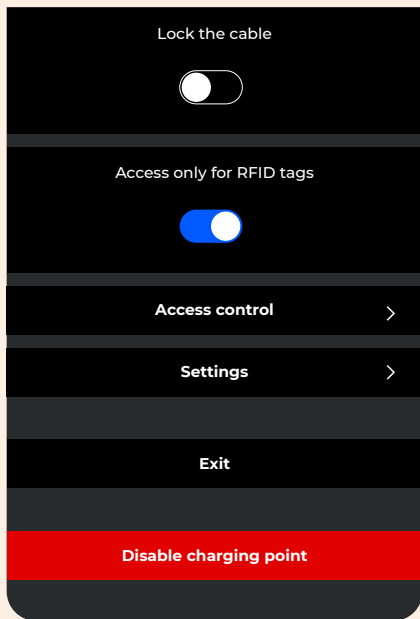

With this toggle you can permanently lock your charging cable in the Type2 connector.

Here it is possible to limit the access to this charging robot.

Under “Access control”, one or more RFID tags can be added, modified or removed.

In settings you have the following options:

- Power management - where you can enable 3-phase charging on IT/TT grid.
- Connect to a local Wi-Fi network.
- Change language.
- Installation setup - to access this, the power needs to be turned off and on again. *(Authorized personnel only)*
- Reset the charging robot.

Technical specifications

Charging

Charging power: 1.4 - 22 kW

Charging connector: Type 2

Number of phases: 1, 2 or 3

Voltage: 230V / 400V AC (+ -10%)

Automatic locking of the charging connector

Built-in energy meter

Easee Home: Up to 3 charging robots on the same cable

Easee Charge: Fully scalable

Safety

Built-in RCD Type B (30mA AC / 6mA DC)

RCD device is automatically reset by disconnecting the charging cable.

Degree of protection: IP54

Impact resistance: IK10

Fire class: UL94

Insulation class: II

Surge class: III

Communication

Connection with Wifi 2.4 GHz b/g/n
Control charging with the Easee app
Built-in 4G / GPRS (requires subscription)
RFID / NFC reader
OCPP 1.6 via our API

Sensors and indicators

Led strip showing status
Touch sensor for disabling smart charging
Automatic brightness sensor (LED)

Installation

Recommended maximum cable cross section: 10mm²
Tightening torque: 5Nm
Stripping length: 12mm

General

Dimension (mm): H:256 x W:193 x D:106
Operating temperature: - 30°C til +40°C
Weight: 1.5 kg

Load balancing

When several charging robots are connected to the same fuse, the total current will be divided automatically and dynamically between the units. The total load will therefore never exceed the specified threshold for the fuse.

Depending on which product variant you are using, you can connect up to 3 Charging Robots (*Easee Home*) to the circuit or scale the infrastructure as you like (*Easee Charge*). All connected cars can be charged simultaneously and the available charge-current is automatically shared between them, provided that there is enough capacity.

Load-balancing occurs through proprietary wireless technology, which does not require any additional infrastructure, cloud-connection or even Internet.

The first charger to be configured will become the main-unit in the system. The other units communicate with the main-unit, such that available capacity can be shared automatically between connected units.

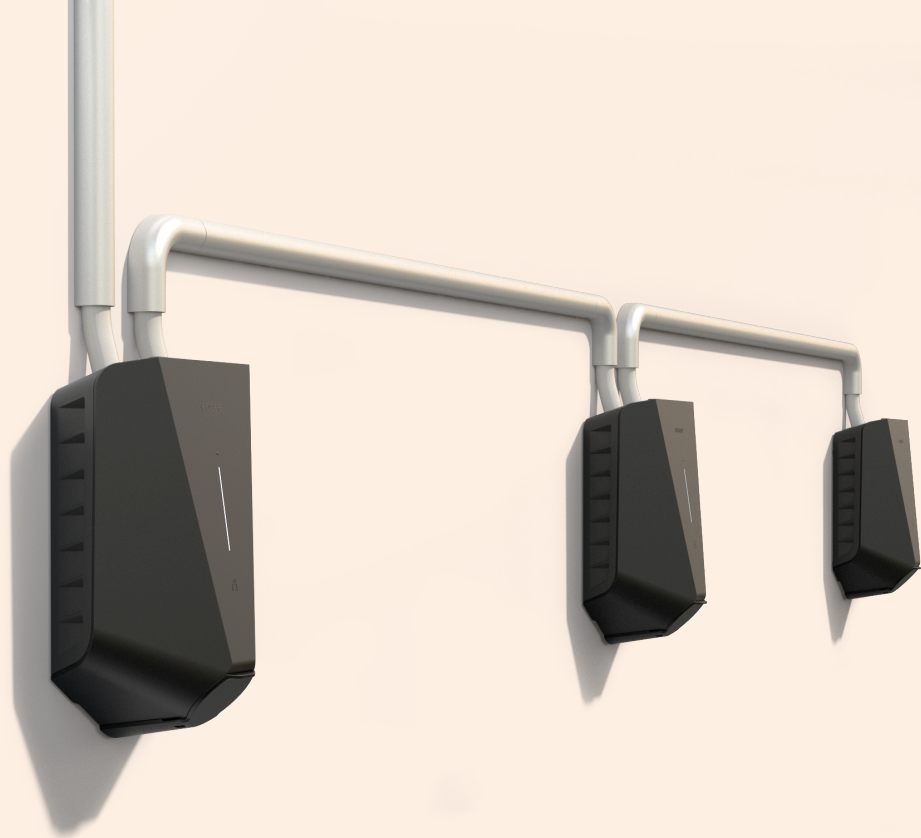

Residual current device - Type B

The built-in protection in the charger is electronic and turns off the power to the electric car if it measures a DC leakage current of 4-6mA and/or an AC leakage current of 20-30mA.

This provides selectivity in the system, meaning it normally won't trigger an external Type A protection device in the event of a fault (AC and/or DC).

The electronic protection in the charger is easily reset by plugging the charging cable in and out of the electric car's charging socket.

We recommend that an external ground fault protection (type A) is used in the distribution cabinet. This is primarily to protect against touching any damaged supply cables or other connection material, but it is up to the authorized electrician to plan and evaluate each installation.

The B protection in the charger will not affect the function of other (external) protection devices.

Practical details

Warranty

We warrant that the device is free from materials defects and is in accordance with laws and regulations for consumer protection in the country where the product is purchased or where the consumer lives. There is more information about the rights granted by consumer protection laws at - easee.no/privacy

User Data

Easee AS obtains data from the product via 4G / GPRS and via the network. You can find more information about our privacy policy at - easee.no/privacy

Returns & complaints

Contact your dealer or easee regarding the return and complaint of your product - easee.no/contact

Useful links

Download the latest manuals - www.easee.no/manuals

Find answers to your question - www.easee.no/faq
or contact support - www.easee.no/support

Light strip error messages

The light strip lights constantly red

This indicates an insulation fault either in the charging cable, connector or EV. Disconnect the charging cable and then reconnect it. If charging does not start and the light turns red again, please try another cable or consult your distributor.

The light strip lights constantly red and you hear a warning sound from the charger

This indicates that the installer has connected the wires incorrectly. Connect it in accordance with the installation guide provided and try again.

The light strip pulses red

The Charging Robot has become too hot. This may be due to an ambient temperature above 40°C or an internal fault in the Charging Robot. If it does not stop pulsing red after a while, consult your distributor.

The light strip flashes white in the bottom

The Charging Robot is trying to connect to the main unit. Normally, the light will stop flashing after a minute, but if it continues to flash it might be because the main unit is either disconnected or updating its firmware (this can take up to 30 minutes).

The light strip flashes yellow in the bottom

The Charging Robot is waiting to be configured. If this is a new installation, follow the “Quick Guide - installation” from step 6 in order to complete the configuration.

The entire light strip flashes white

The Charging Robot awaits authentication by an RFID-tag. Present your RFID-tag at the wireless-symbol at the “nose” of the Charging Robot in order to authenticate and initiate the charging.



Powering your freedom



Paste
PIN



Easee AS
Professor Olav Hanssens vei 7A
4021 Stavanger, Norway